

TRACK BUILDING INSTRUCTIONS

Designed by

COMPUTER PINEWOOD DERBY
5438 S. Lapwai Place
Boise, ID 83709
Ph. (208) 362-0728

MATERIALS NEEDED

1	4' x 8' x 1/2" Plywood - Hardwood Veneer or sanded shop grade		
9	1/4" x 1 3/4" x 8' Hardwood or hemlock strips		
1	2" x 4" x 8' two by four, good quality with tight knots		
2	1" x 3" x 8' wood strips		
8	Stimpson TA-9 stringer (stair brace)		
4	2" Tee Hinges	24	Flush wood screws, #6 x 3/4"
8	1/2" x 1 3/4" Hardwood dowels	24	Round head screws, #14 x 3/4"
8	Hex head bolts, 1/4" x 3/4"	8	Hex nuts, 1/4"
18	Flush wood screws, #6 x 1 1/4"	28	Flush wood screws, #6 x 5/8"
4	Wood screws, #8 x 1"		3/4" brads
	Wood Glue		1 1/4" brads

TOOLS NEEDED

Table saw	Phillips screw driver	1/2" drill bit w/ 3/8" shank
Radial arm saw	3/8" Drill Motor	1/8" drill bit
Hammer	Doweling jig	5/32" drill bit
Carpenter's square	Four 8" clamps	Felt tip marker, wide

When attaching Starting Gate and Ending Gate, you will need a 1" wood drill bit and a jig saw (Saber Saw). Instructions for cutting Starting Gate and Ending Gate slots are provided with electronic package.

TRACK SECTIONS

Cut 4' x 8' plywood sheet into 5 track sections - 9" x 8'. Cut fifth 9" x 8' track section into one 9" x 24" short track section, twelve 9" x 4" pieces, and two 9" x 3" pieces. From 2" x 4" x 8', cut nine 2" x 2 1/2" x 9" blocks. Cut one 1" x 3" x 8' wood strip in half. Cut 2nd 1" x 3" x 8' wood strip into two 1" x 3" x 16", and four 1" x 3" x 9" pieces.

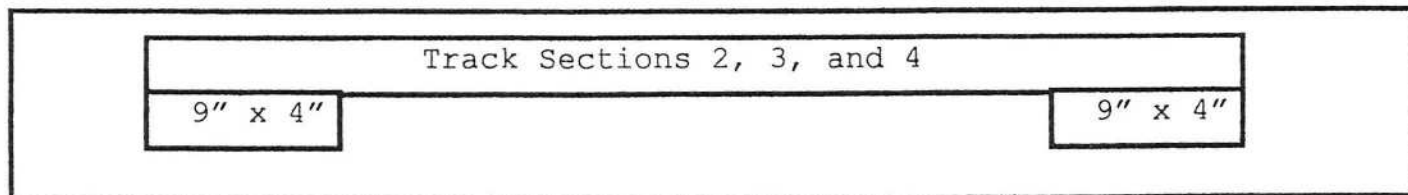

Figure 1

Write "Section 1", Section 2", etc., on bottom (unfinished) side of all four 8 foot track sections. Apply wood glue to bottom of one 9" x 4" plywood piece and corresponding section of the bottom of track sections 1. Position 9" x 4" piece to end of track, making sure that ends and edges of both track and piece are flush. Drive 3/4" brads through two corners of glued piece farthest from butt end. Repeat for each of the other 7 remaining glued track sections ends. Stack track sections with top track surfaces together, four deep, then clamp together. Allow glue to dry overnight.

DOWELING TRACK

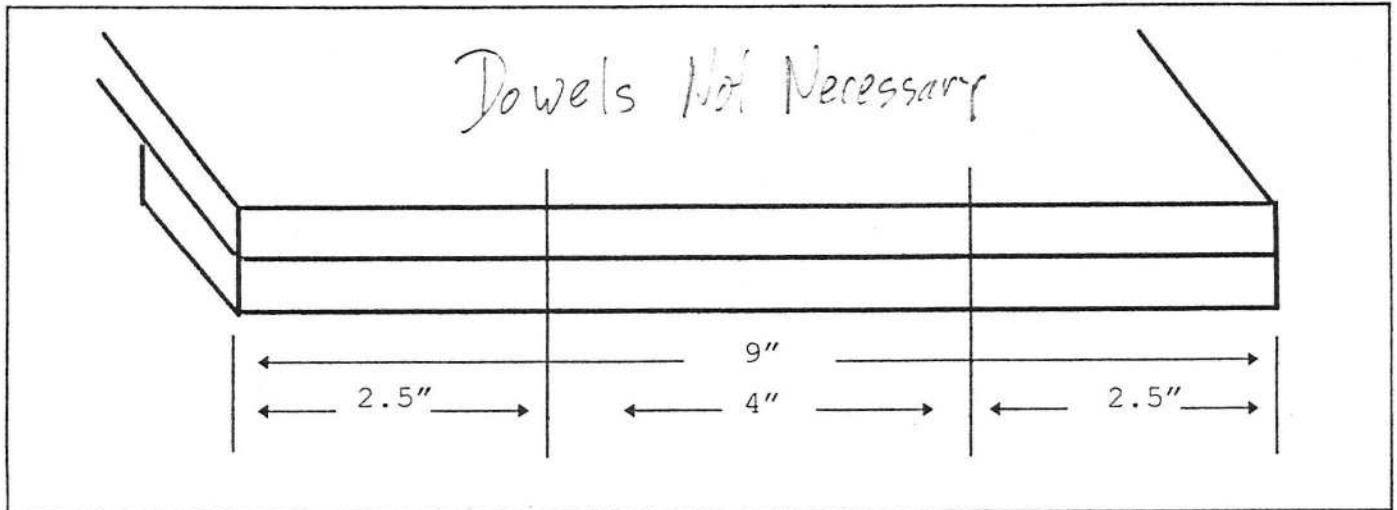

Figure 2

Using radial arm saw, carefully cut enough wood (1/8") off of the end of track to form a smooth square edge. Mark the top surface of one glued track sections for doweling with pencil. These perpendicular marks must be 4" apart and exactly 2.5" from each edge of the track. Now butt the adjoining track section's end up to the end just marked. When tracks are properly aligned, pencil mark corresponding marks on other track end. Repeat as necessary.

Attach doweling jig to the end of track section. Align 1/2" drill guide over pencil mark drawn on end of track section. Drill 1/2" hole to a depth of 1".

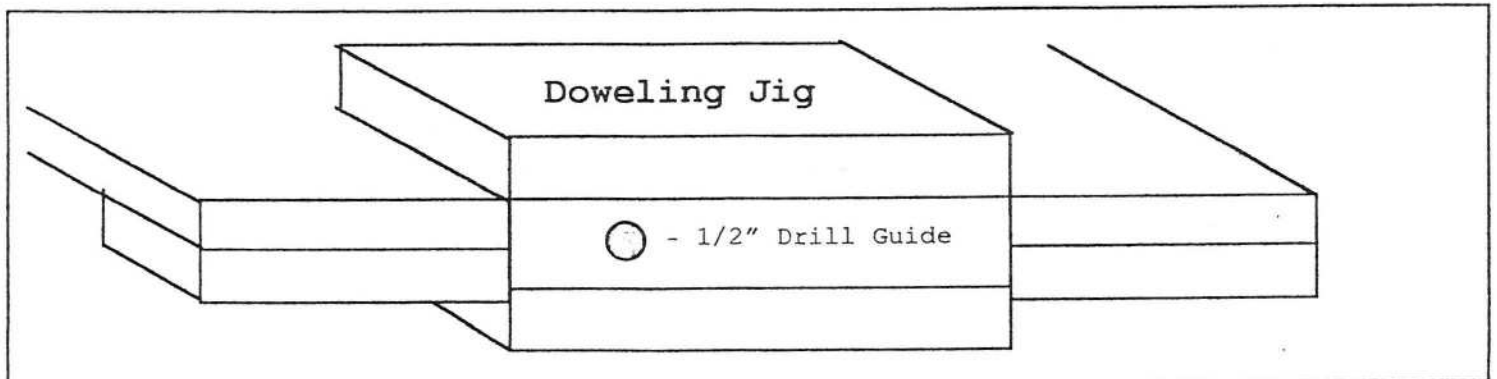

Figure 3

Drill 2nd hole on other side of track section. Repeat on each of 8 glued track sections ends (including one end of section 1 and one end of short section), a total of 16 holes. Track end section should look like this:

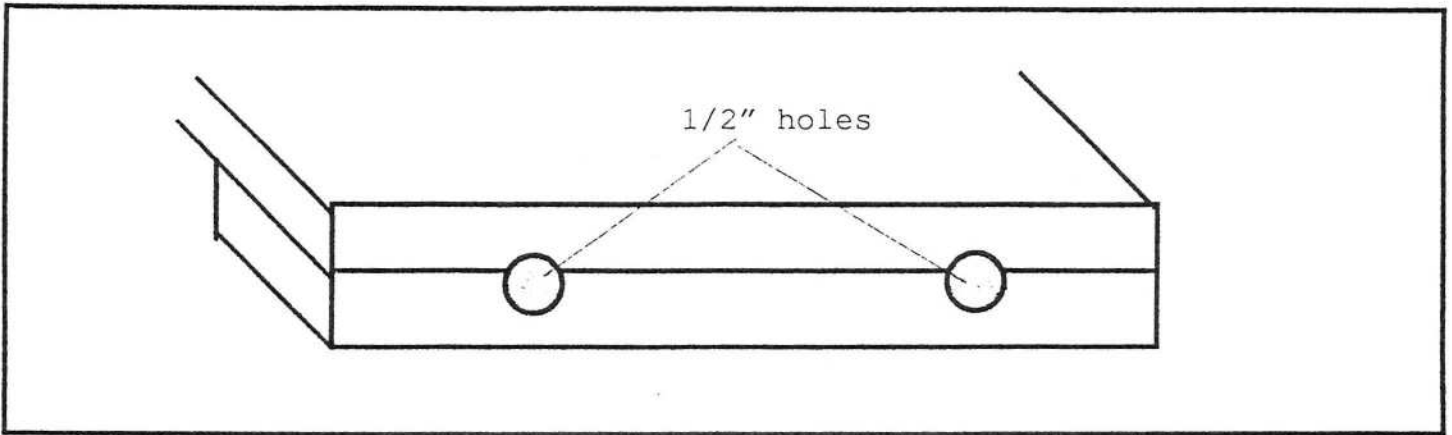

Figure 4

TRACK SUPPORTS

Attach four 2 1/2" x 9" blocks to underside of track sections 3 and 4. Attach last block to non glued end of short track section. Drill countersunk holes 2.5" from edge of track. Secure wood supports with a 6 x 1 1/4" countersunk screw through the track into the supports. The supports on the ends of the track sections should butt right up to the 9" x 4" glued plywood piece. (Screws will be concealed by track center strips).

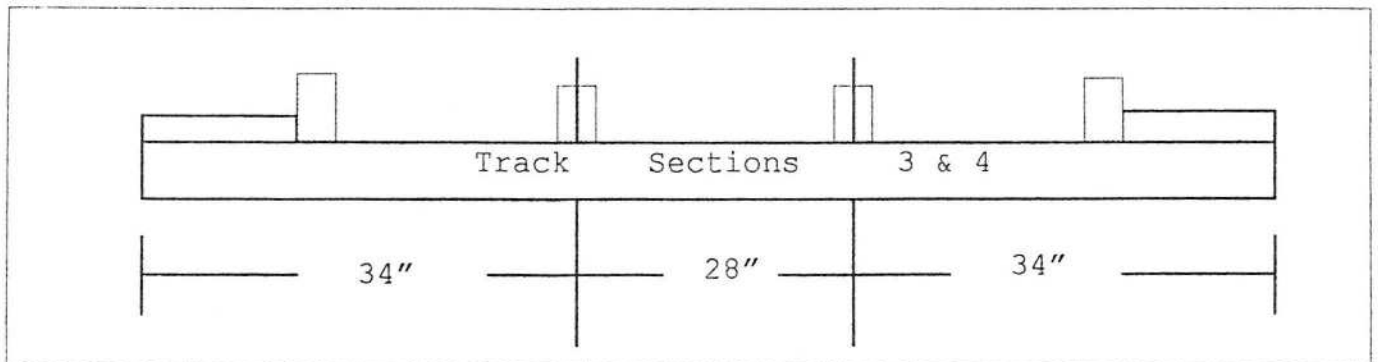

Figure 5

ATTACHING SIMPSON TA-9 BRACE

Turn track section 1 and 2 upside down on clean floor. Align sections end to end, making sure direction of travel is the same for each section. Insert dowels into dowel holes and slide track sections snugly together. Attach 2 Stimpson TA-9 braces together by inserting the two 1/4" by 3/4" hex head bolts through the two sets of holes and attach nuts and tighten.

NOTE: The holes in one TA-9 brace may not automatically align with holes in another TA-9 brace. Find two braces whose holes do line up when brace bases are absolutely flat on track surface.

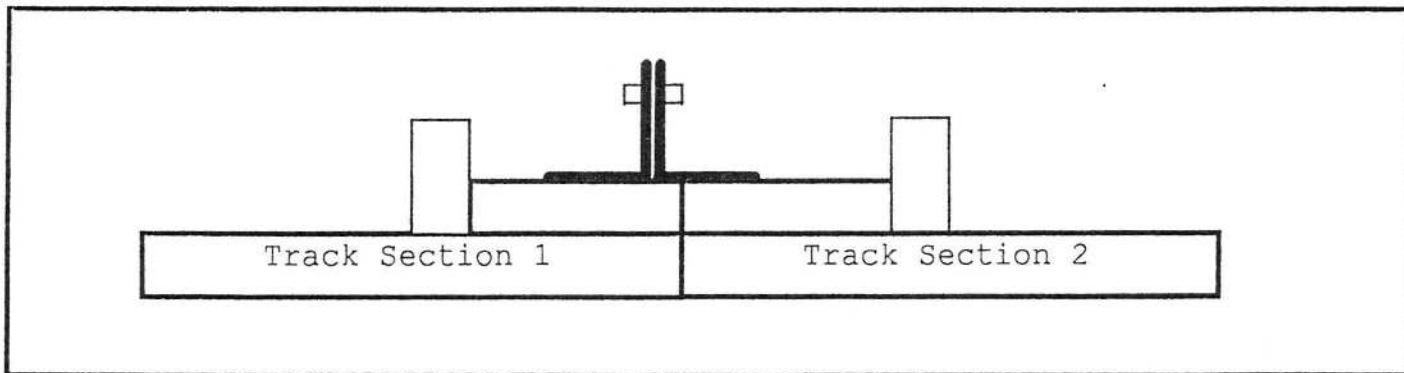

Figure 6

One TA-9 brace should overlap the downhill end of the lower numbered track section by 1/2". This prevents the downhill track section from being higher than the uphill track section, thus preventing bumps at the section joints. For example, when connecting sections 1 and 2 together, the TA-9 will be 1/2" up from the downhill end of track section 1, while the TA-9 on the uphill end of section 2 will extend 1/2" beyond the joint seam.

Square braces to side of track and secure in position. Using 5/32" bit, drill starting holes (1/2" deep) into bottom of track sections in center holes of each TA-9 brace. Do not drill completely through the track, marring the track's surface. Secure brackets to track using six 14 x 3/4" screws. Repeat this process for Sections 2, 3, 4, and end piece.

UPPER TRACK LEGS

Place one 1" x 3" piece of wood to each end of long supports. Square pieces to supports, then secure using glue and nails.

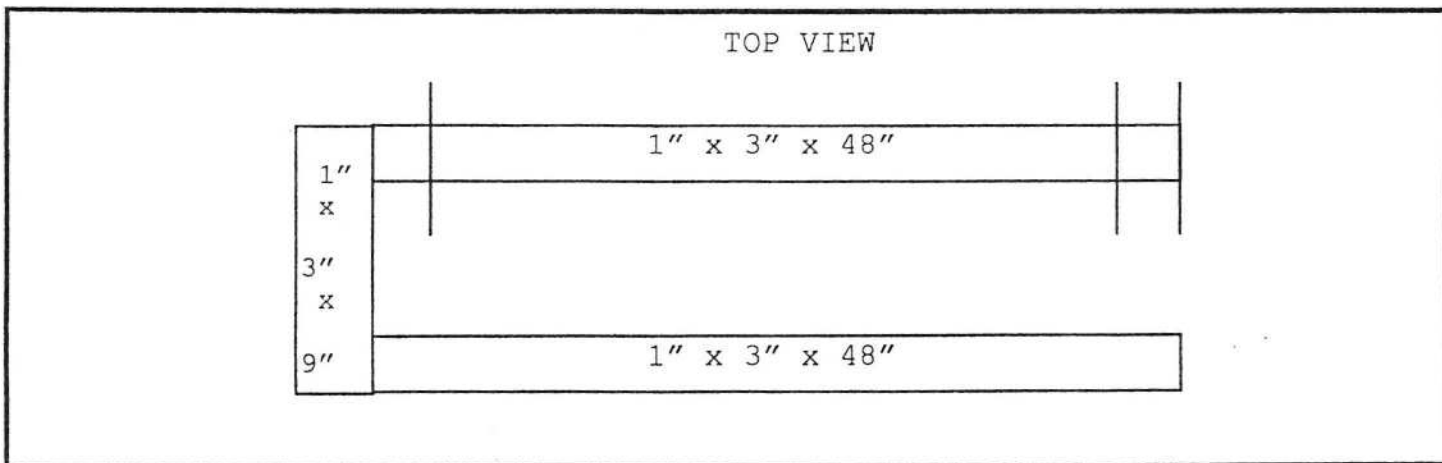

Figure 7

When finished, lay leg supports flush on work bench. Place 9" x 3" piece of wood next to upper edge of support legs. Short piece should be an extension of support legs.

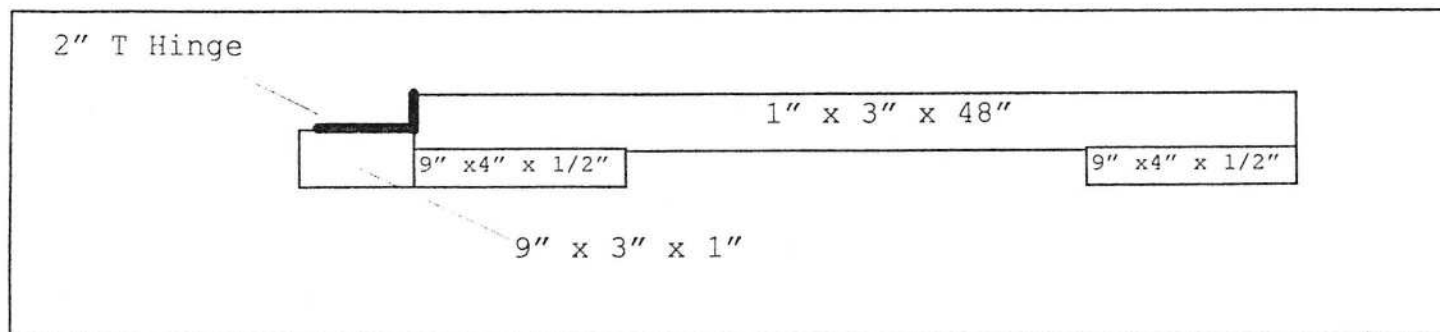

Figure 8

Position the T hinge as shown above. Pre-drill using 1/8" drill bit. Secure with 6 x 3/4" screws. Repeat for hinge on other side.

ATTACHING LEGS TO TRACK

Turn Track section 1 face down. Position the hinged end of 4 foot long legs on upper end of track section 1. Position upper most edge of leg assembly 11" from starting end of track. Make a pencil mark on each edge of the track where upper end of leg assembly should be located.

Turn track over (face up). Align leg assembly with marks. Drill a countersunk hole 2 1/2" from edge of track and aligned with pencil mark. Secure leg assembly to track by with one 8 x 1" screw through track into the 9" x 3" attached piece. Use square to align legs perpendicular with track edge. Repeat process to secure other side of legs to track. These screws will be covered by track center strips (one under each lane).

LOWER TRACK LEGS

Cut two 1" x 3" x 14" short support pieces. Use remaining two 9" x 4" pieces of plywood to form short legs 9" x 16". Use same technique as explained above to build and attach legs to track. Repeat process with short (14") legs as described above. This set of legs should butt up to the glued 9 x 4" piece at upper end of track section 2.

Connect all four long sections of track together using 1/4" hex head bolts and nuts. Turn track right side up. Lift top of track section 1 up, allowing support legs to swing freely. Stand track on legs perpendicular to floor. Lift track at seam of sections 1 and 2, and place short legs perpendicular to floor. Track should have a constant bow in it from the top of the track to near the bottom of section 2.

ATTACHING CENTER STRIPS

Locate the exact center of each hardwood strip at the end of each strip. Drill a countersunk hole (to accommodate 6 X 5/8" screw) 2" from the end of

each strip. Drill 3rd hole at mid strip. Write on the back of each hardwood strip the track section it will be attached to, which lane it is, and an arrow showing direction of travel. This will be very helpful later if you ever remove the strips for painting, etc.

Cut 3 pieces of wood exactly 2 1/4" wide. With track section 1 right side up, center 8' hardwood strips lengthwise on track section. Place a 2 1/4" piece between the two 8' strips at each end, and in the middle, to insure hardwood strips are the same distance apart from center to center. Make sure strips are the same distance from (outer) edges of track section. Strips should be straight and exactly parallel to the edge of track. It doesn't matter if strips are longer than track section at this point.

Secure hardwood strips with clamps at both ends of track section. Verify proper alignment of hardwood strips now as corrections will be difficult later. Drill a 1/8" pilot hole into track section through countersunk hole in hardwood strip. Secure each track strip with 6 x 3/8" countersunk wood screws.

Place end of track section 1 (right side up) on Radial Arm saw and cut off excess of center strip length to provide a clean cut, leaving end of track center strips square, smooth, and flush with end of track section. Repeat process for other end of track. Repeat process for track sections 2, 3, and 4. Be careful not to cut off any of the end of the track sections themselves.

guides $\frac{3}{8} \times \frac{3}{4} \times 8'$
 track is $3\frac{3}{8}$ " wide

Also Make a track section 6" long for the timer

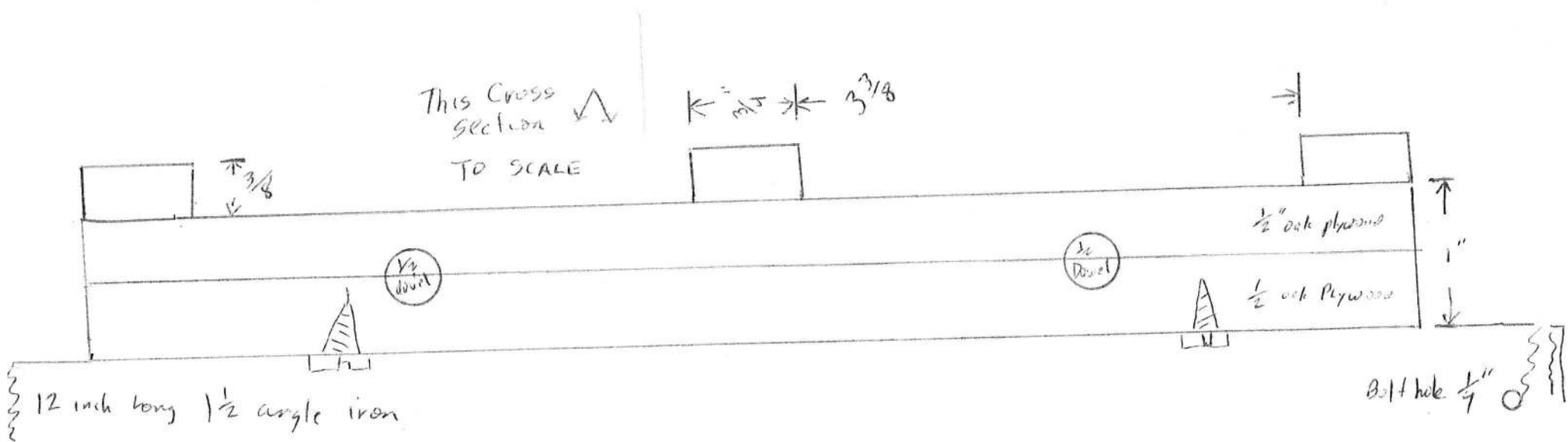
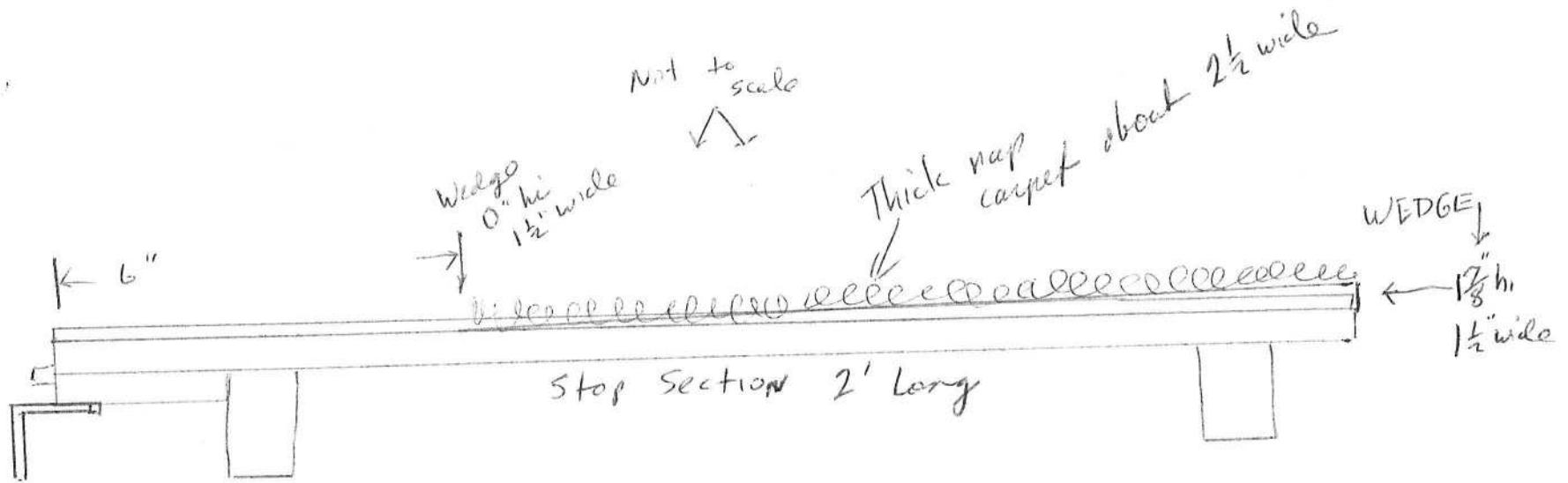

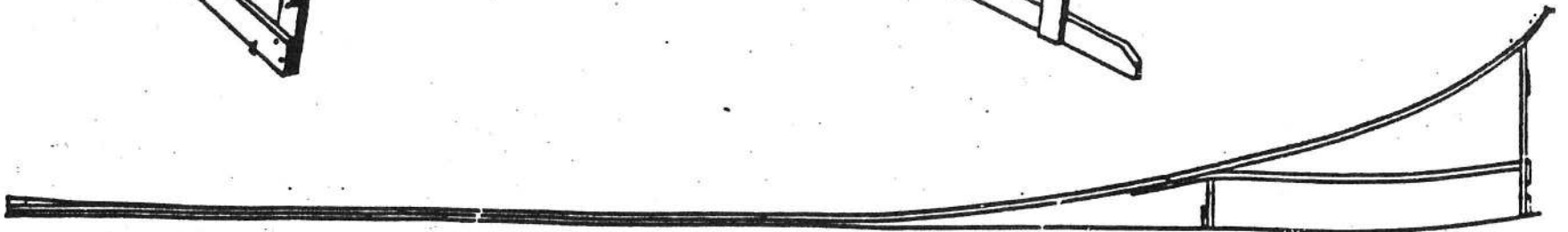
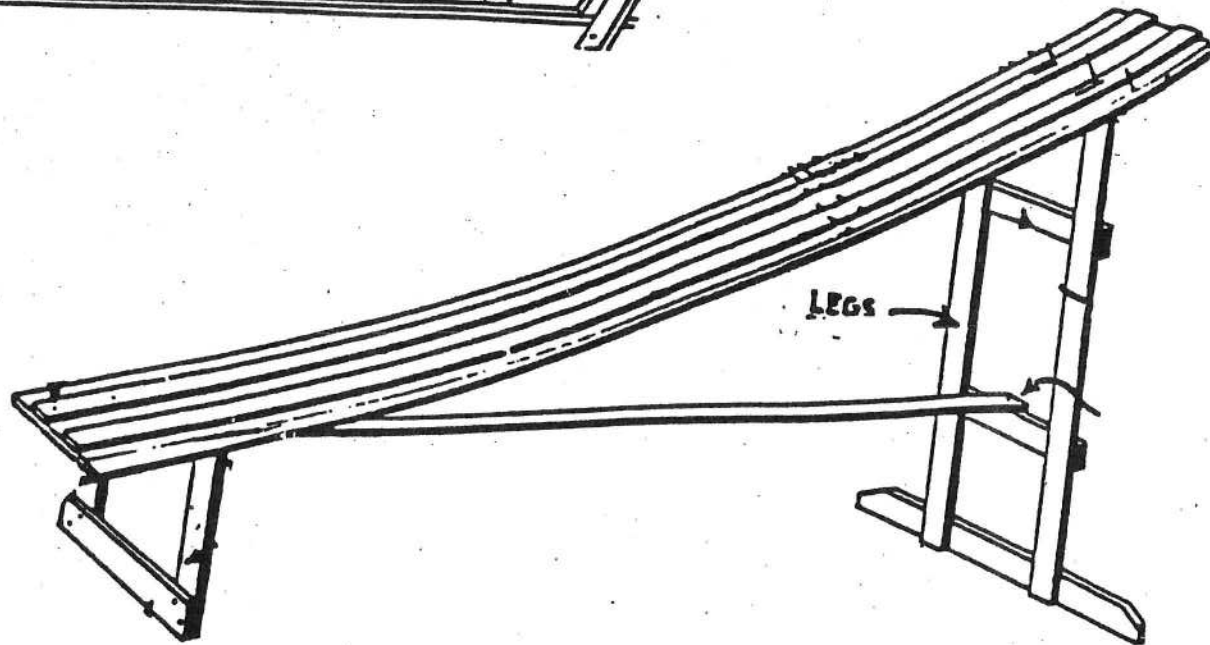
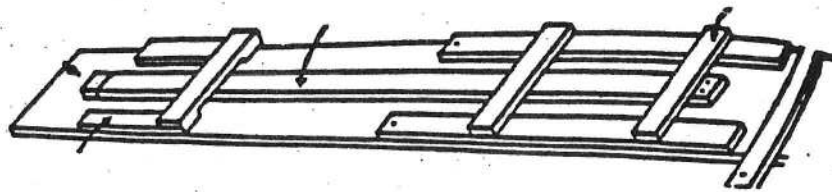

PINEWOOD DERBY TRACK

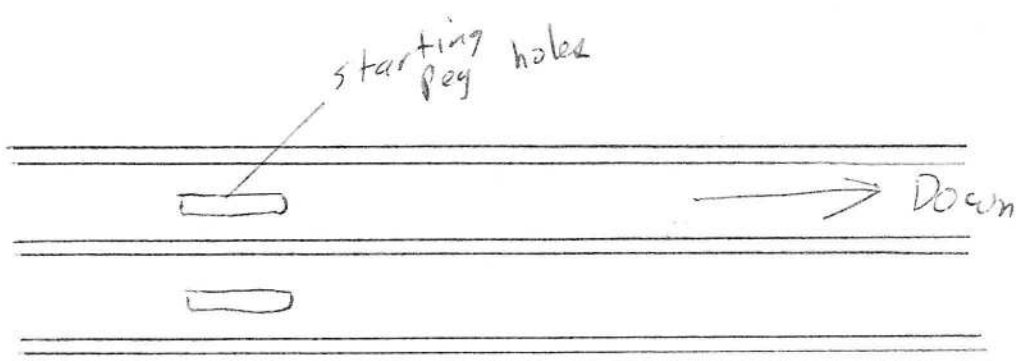
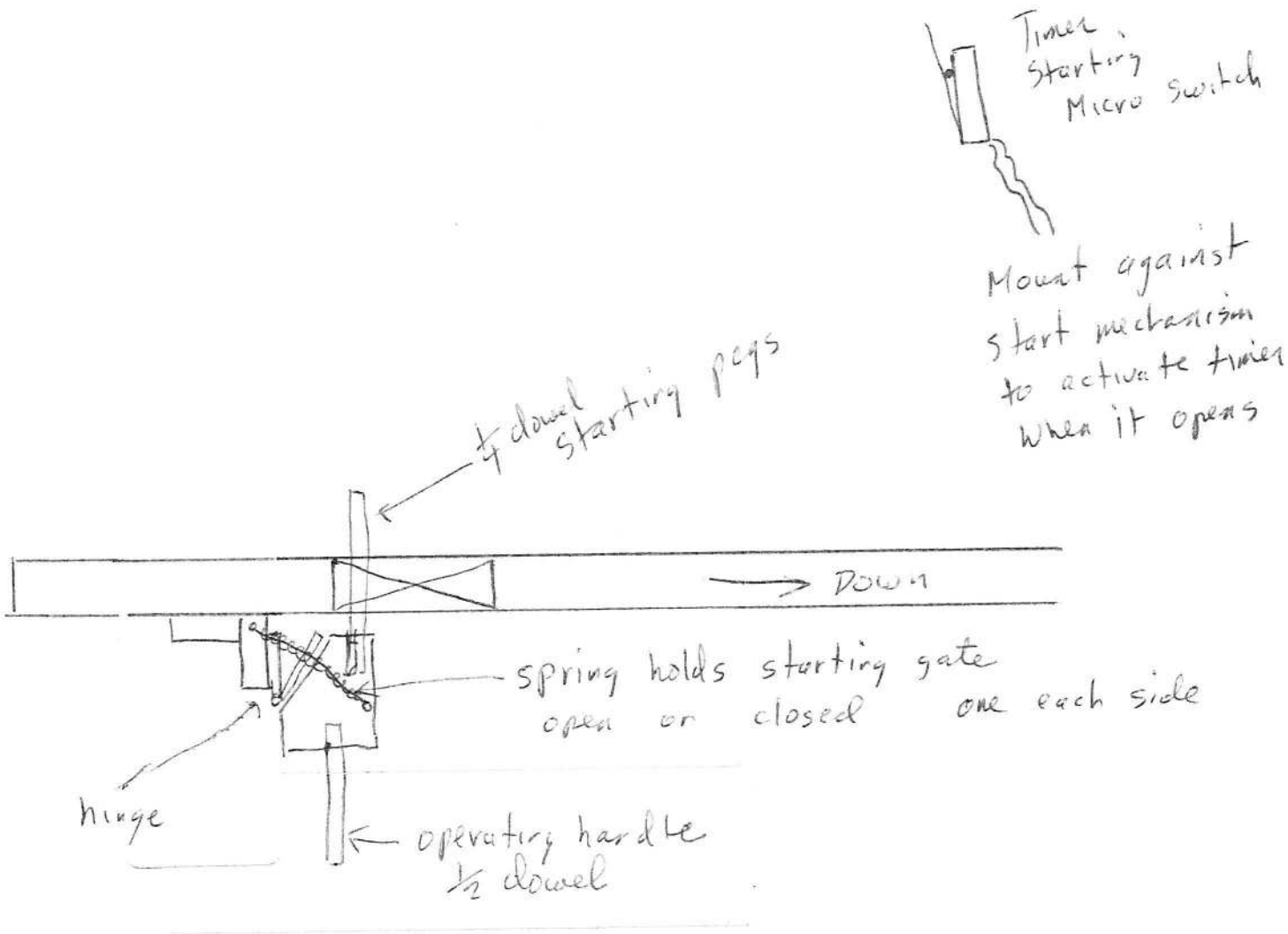

March 7, 2008

When the second track was built here the angle iron pieces were not used to join sections.

Rather a groove was routed in the side of each section and a tight fitting iron bar that had been threaded at each end could be inserted. There were holes above in the guide rails to match the threaded iron bars. Counter sunk allen bolts with a washer were tightened into the countersunk rails and threaded holes.

This both connected the track sections together and took care of the tendency to kink at the joints.

